

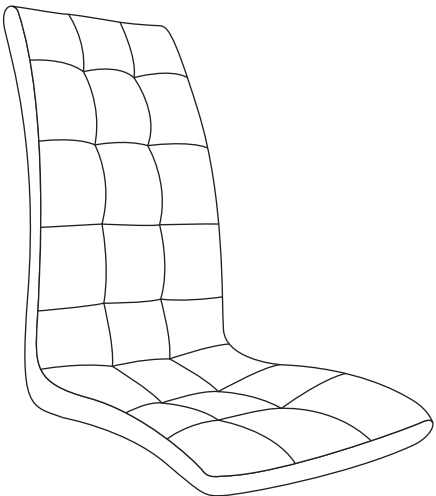

1

2

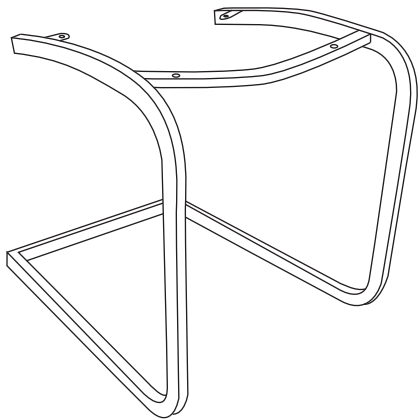

1	1x
2	1x

**A**



M6x16mm

2x

**B**



M6x25mm

2x

**C**



∅18x 6x1.5mm

4x

**D**



M5

1x

1

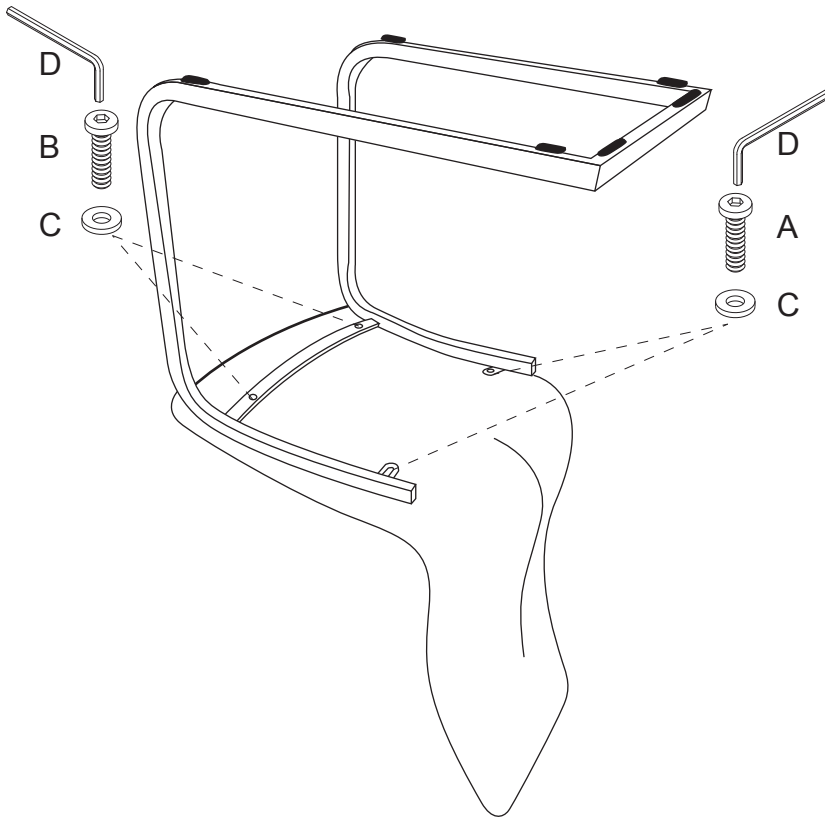

2

